

ENGLISH

Binatone Simply better

STAND FAN



To get the best results from your Binatone product
please read these instructions carefully.

A-1612RC



Binatone has an incredible heritage.

Established – 1958 in London, UK.

We are an absolutely customer centric company!

With more than 60 years delivering quality products to our customers in more than 75 countries – our global footprint enables economies of scale.

This allows us to offer you some of the world's highest performance, quality & value products available in the market today.

Our commitment lies solely in delivering high quality, affordable products.

Our international team is constantly pursuing every effort to make products not just 'appliances' but 'lifestyle improvements'.

Check out all the latest Binatone products at:

www.binatonelifestyle.com

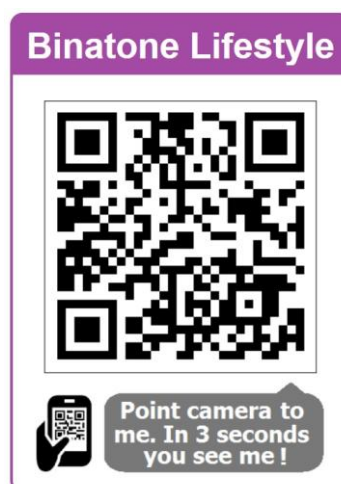

IMPORTANT SAFEGUARDS

When using electrical appliances – especially when children are present, basic safety precautions should always be followed to reduce the risk of fire, electric shock and/or injury to persons.

- ✓ READ ALL INSTRUCTIONS
- ✓ Make sure your power supply is consistent with the rated specification of the product before connecting.
- ✓ This appliance is not intended for use by persons (including children) with reduced physical, sensory or mental capabilities or lack of experience and knowledge – unless they are under supervision or instruction concerning use of the appliance by a person responsible for their safety. Children should be supervised to ensure that they do not play with the appliance.
- ✓ Do not operate any electrical appliance with a damaged cord or plug – or after the appliance malfunctions or has been dropped or damaged in any manner. Return the appliance to the nearest authorised service facility for examination, repair or adjustment.
- ✓ This product is intended for domestic indoor use only. Do not use outdoors or for commercial purposes.
- ✓ To protect against electric shock, do not place the product, cord or plug in water or other liquid.
- ✓ This product should not be used in the immediate vicinity of water, such as bathtub, washbowls, swimming pool etc. where the likelihood of immersion or splashing could occur.
- ✓ Unplug from the power outlet when not in use & before cleaning.
- ✓ Do not pull, twist or otherwise abuse the power cord.
- ✓ Use this appliance only for its intended use – as described in this manual.
- ✓ Do not insert fingers, pencil or other articles through the slots during operation.
- ✓ The use of accessory attachments not included, recommended or sold by Binatone is prohibited and may cause damage, fire, electric shock or injury.
- ✓ Do not operate the fan in the presence of explosive and/or flammable fumes.
- ✓ Do not place the fan or any parts near an open flame, cooking or other heating appliance.
- ✓ Do not operate if the fan housing is removed or damaged.
- ✓ Do not operate the fan without the protective front and rear grilles in position.

SPECIFICATION

Power: AC 230V~ 50Hz 65W

KNOW YOUR APPLIANCE

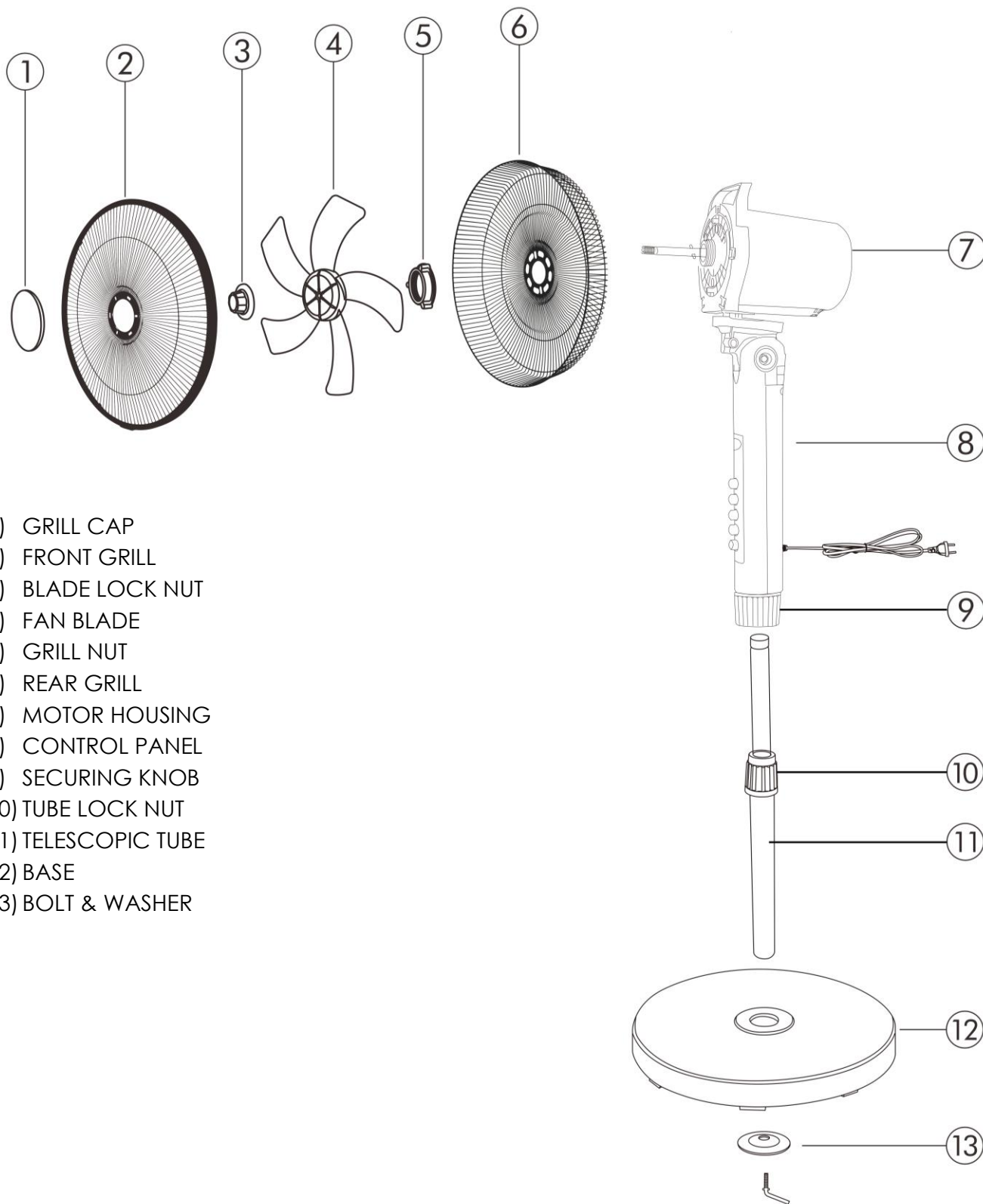

- 1) GRILL CAP
- 2) FRONT GRILL
- 3) BLADE LOCK NUT
- 4) FAN BLADE
- 5) GRILL NUT
- 6) REAR GRILL
- 7) MOTOR HOUSING
- 8) CONTROL PANEL
- 9) SECURING KNOB
- 10) TUBE LOCK NUT
- 11) TELESCOPIC TUBE
- 12) BASE
- 13) BOLT & WASHER

CONTROL PANEL

Front Panel

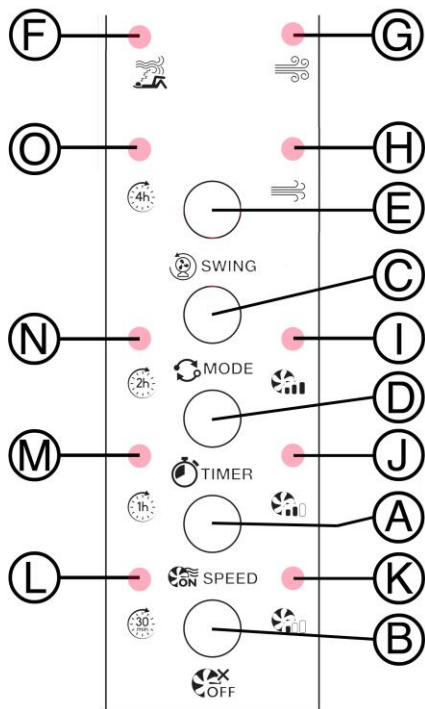

Remote Control

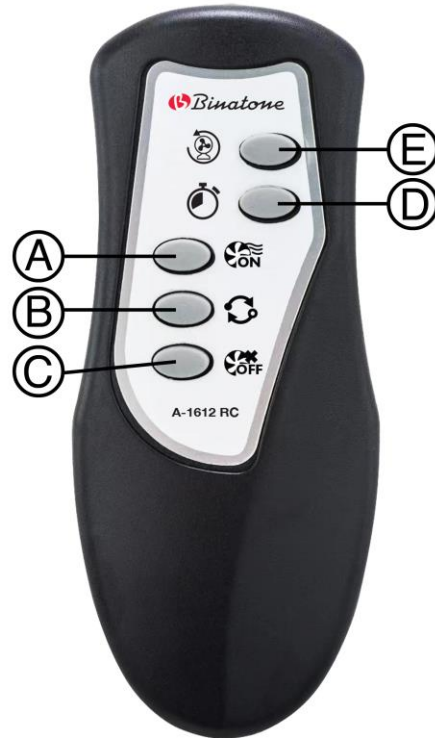

Note : LED positions shown in above image are for indication only – actual LED's are hidden until illuminated.

- A) ON/SPEED Button
- B) OFF Button
- C) MODE Button
- D) TIMER Button
- E) SWING Button
- F) SLEEP Mode LED
- G) NORMAL Mode LED
- H) NATURE Mode LED

- I) HIGH Speed LED
- J) MEDIUM Speed LED
- K) LOW Speed LED
- L) 30 minutes (0.5Hr) TIMER LED
- M) 1.0Hr TIMER LED
- N) 2.0Hr TIMER LED
- O) 4.0Hr TIMER LED

BEFORE FIRST USE

Carefully remove all packaging and assemble the product following the setup & operating instructions below.

SETUP INSTRUCTIONS

Head Unit - Fan Blade & Protection Grill Assembly

- Place the rear grill (6) on the motor housing (7)
- Secure it using the grill nut (5) - turn clockwise to tighten by hand, do not over tighten
- Push the fan blade (4) onto the motor drive shaft aligning it carefully
- Secure the fan blade (4) with the fan lock nut (3)
- Assemble the front grill (2) to the rear grill (6)

Base Assembly - Telescopic Tube to Base

- Place the base (12) on the floor
- Insert the telescopic tube (11) into the recess on the top of the base
- Secure using the bolt & washer (13) provided

Head Unit to Base Assembly

- Pull up the telescopic tube (11) and tighten the tube lock nut (10).
Caution: The height adjustment knob (10) must be fully tightened before assembling the motor section to the pedestal stand assembly.
- Fit the head unit to the base assembly and tighten the securing knob (9).
Caution: The securing knob (9) must be fully tightened before the fan is switched on.

OPERATING INSTRUCTIONS

1. Make sure that the fan is on a firm and level surface.
2. Plug the fan into a standard 230V~ outlet.

Note: The buttons on the control panel and remote control are marked the same - so you can use either of them to control the stand fan.

3. ON 

Press the ON/SPEED Button (A) – on 1st use, the unit will start in LOW speed (NORMAL mode).

You can press the ON/SPEED Button (A) again to cycle the speed between:

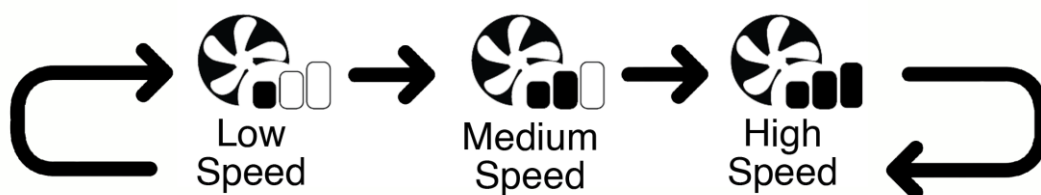

Note: The panel will illuminate to show which SPEED is selected – LED's (K), (J) & (I).

OPERATING INSTRUCTIONS continued

4. OFF 
Press the OFF Button (B)

Memory Function

When you switch the unit off but leave it connected to the socket (and power is on) - The A-1612RC will remember which speed & mode(*) you last used! On your next use, it will commence operation in the last speed & mode set.



However, if the unit is unplugged or there is a power cut, the memory will be lost, and the unit will default back to LOW speed and NORMAL mode when you use it next time.

(*) SLEEP Mode & TIMER settings are not included in the memory function. SLEEP Mode will reset to NORMAL Mode.

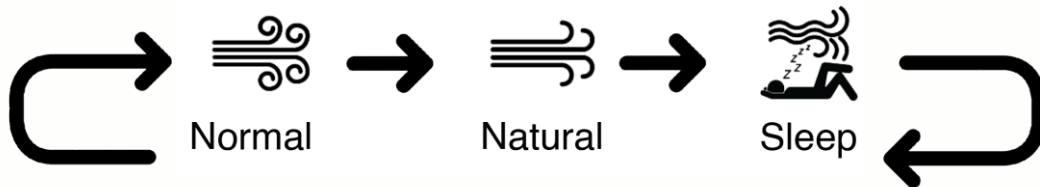
5. MODE 
To select the fan mode, press the MODE Button (C) – the unit will switch to SLEEP Mode. You can press the MODE Button (C) again to cycle the mode between:



Note: The panel will illuminate to show which MODE is selected – LED's (H), (G) & (F).

MODE	FUNCTION
 Normal	Conventional wind - at the set speed This can be used with all SPEED settings
 Nature	Creates an irregular & variable wind that is softer and more comfortable. This can be used with all SPEED settings
 Sleep	The fan speed will slowly decrease to aid sleep – as indicated below: 1) HIGH speed - fan operates for 0.5hr (30 minutes) then reduces to MEDIUM speed. After a further 0.5hr (30 minutes) it will reduce to LOW speed until the TIMER time is over or turned off. 2) MEDIUM speed – fan operates for 0.5hr (30 minutes) then reduces to LOW speed until the TIMER time is over or turned off. 3) LOW speed - the fan operates until the TIMER time is over or turned off.

OPERATING INSTRUCTIONS continued

6. TIMER

The timer allows you to set the runtime between 0.5hrs (30 minutes) to 7.5hrs (450 minutes) in 0.5hrs (30 minute) steps. When the timer function ends the unit will automatically switch off.

To set the timer – each press of the TIMER button (D) will add another 0.5hrs (30 minute) – cycling in steps:

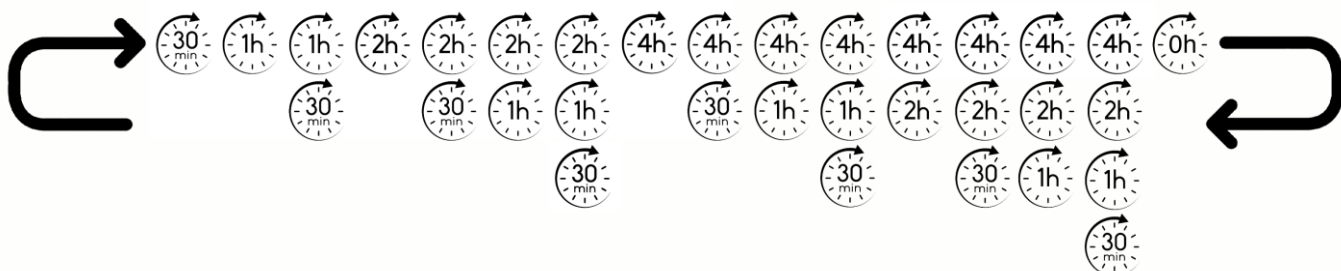

Note: As the time is increased – more than one LED will illuminate as shown above - to designate the time selected - LED's (L), (M), (N) & (O).
(eg 4.5hrs is shown as 4hrs (O) + 30mins (L) LED's illuminated)

To cancel the timer - press the TIMER button (D) multiple times until all LED's ((L), (M), (N) & (O)) are off.

7. SWING

Fan head can be oscillated from left to right.

To start the oscillation – press the SWING button (E).

To stop the oscillation – press the SWING button (E).

8. TILT

Fan head can be tilted up and down.

To tilt the head, simply move the motor housing (9) up or down gently until the fan is positioned as required. A series of clicks will be heard - this is normal.

AIR FRESHNESS

The Air Freshness module can be used as an Air Freshener or as a Mosquito Repellent by soaking the provided sponge pads with appropriate liquids.



We recommend that the sponge pads are sprayed/soaked with appropriate liquid, depending on operation mode. The sponge pad should be thoroughly wet but not dripping wet before inserting to your fans Air Freshness module.



MOSQUITO
REPELLENT

Orange sponge pad

can be used exclusively for the soaking of mosquito repellent liquid (*)



AIR
FRESHENER

White sponge pad

can be used exclusively for the soaking of air freshener liquid.

To fit the sponge pad - firstly, locate and remove the Air Freshness module grill cap (H) on the front grill (G).

To unlock, rotate counter clockwise and remove the grill cap (H).

Fit the soaked sponge pad to the inside of the grill cap (H) - push it in carefully, the tabs will secure it in place.

Refit the grill cap/sponge pad assembly to the front grill (G) and rotate clockwise to lock in place. Operate the fan as usual, following the user guidelines.

Note: the soaked sponge pad will dry out as the liquid is dispersed - this is normal. We recommend checking and recharge the sponge pad every 3-4 hours.

(*) **CAUTION** : Select a safe mosquito repellent liquid for use with this product. Many insecticide type products are unsafe for humans and animals through inhalation or contact with skin & eyes. Read the safety instructions of the repellent liquid carefully. If in doubt do not use it.

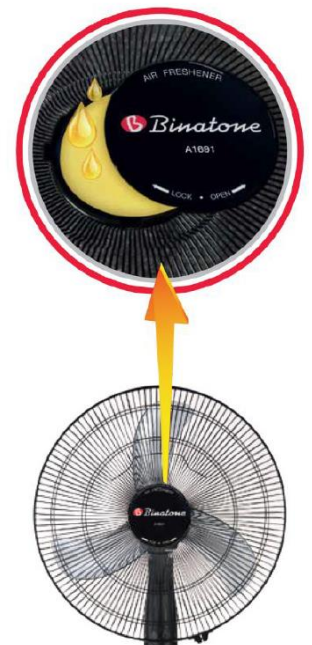

CARE AND CLEANING

This appliance requires little maintenance.

We recommend dust is cleaned from the fan blade and protective grills every few months, to keep it operating optimally.

After use and before cleaning, ensure the fan is OFF and the blades have come to a complete stop. Unplug the fan from the socket.

Disassemble the front & rear grill & fan. Wipe parts with a damp cloth.

Do not use abrasive cleaners, harsh detergents, chemical cleaners or solvents as they may damage the surface finish of the plastic components.

Refit the parts following the assembly instructions

Wipe the outside of oscillating fan body with a damp cloth and dry with another cloth or paper towel.

SERVICE & CUSTOMER CARE





There are no user serviceable parts inside this appliance.

If the power cord or plug are damaged it must, for safety reasons, be replaced by Binatone or an authorised Binatone repairer.

If you need help with:

- using your product
- servicing or repairs (in or out of guarantee)
- spare parts (fan blade, grill covers, locking nut)

Please contact Binatone Customer Service at:

	<p>www.binatonelifestyle.com/binatone/customer-service</p> <p>/</p>	
	<p>www.facebook.com/BinatoneAfrica</p> <p>or search @BinatoneAfrica in Facebook or Messenger to find this page easily.</p>	

Have your model number & batch code ready – it is located on the rating label on your product

WARRANTY



Save your proof of purchase sales receipt.

BINATONE warrants, subject to the conditions stated below, that from the date of purchase, this product will be free from mechanical defects for a period of two (2) years.

This is a domestic product – warranty does not cover products that have been used for commercial purposes.

BINATONE at its option, will repair or replace a product found to be defective during the warranty period. Should this product become defective by reason of improper workmanship or material defect during the specified warranty period, BINATONE will repair or replace the same effecting all necessary part replacements.

Transportation charges on parts, or products in whole, submitted for repair or replacement, under this warranty, must be borne by the purchaser.

CONDITIONS: This warranty is valid for the original retail purchaser from the date of initial retail purchase and is not transferable. Keep the original sales receipt. Proof of purchase is required to obtain warranty service or replacement. Dealers, service centres, or retail stores do not have the right to alter, modify or in any way, change the terms and conditions of this warranty.

Warranty registration is not necessary to obtain warranty on BINATONE products.

ABOUT YOUR PRODUCT WARRANTY: Most warranty repairs are handled routinely, but sometimes requests for warranty service may not be appropriate. For example, warranty service would NOT apply if the product damage occurred because of misuse, lack of routine maintenance, shipping, handling, warehousing or improper installation. Similarly, the warranty is void if the manufacturing date or the serial number on the product has been removed or the equipment has been altered or modified. During the warranty period, the authorized service dealer, at its option, will repair or replace any part that, upon examination, is found to be defective under normal use and service.

NORMAL WEAR & SERVICE/REPLACEABLE PARTS: This warranty does not cover normal wear of parts or damage resulting from any of the following: Negligent use or misuse of the product; Improper voltage or current; Use contrary to the operation instructions; Deviation from instructions regarding storage and transportation; Repair or alteration by anyone other than BINATONE or an authorized service centre; service parts replaced by user. Further, the warranty does not cover Acts of God, such as fire, flood, hurricanes, tornadoes etc.

Customers connecting BINATONE appliances directly to the mains power outlet or using a non-BINATONE stabilizer, risk voiding their BINATONE warranty. We recommend using quality BINATONE stabilizers for your protection – be wise, buy the best – always buy BINATONE

HOW TO OBTAIN WARRANTY SERVICE: Please contact BINATONE Customer Service (see Service & Customer Care section)



**Please consider recycling this
instruction manual responsibly**

Binatone Lifestyle Appliances

• LONDON • HONG KONG • DUBAI • LAGOS • ACCRA •