

ENGLISH

 **Binatone**  
Simply better

## 6.5L RAPID AIR FRYER



To get the best results from your Binatone product  
please read these instructions carefully.

**BAF-6500**



**Binatone has an incredible heritage.**

**Established – 1958 in London, UK.**

We are an absolutely customer centric company!

With more than 60 years delivering quality products to our customers in more than 75 countries – our global footprint enables economies of scale.

This allows us to offer you some of the world's highest performance, quality & value products available in the market today.

Our commitment lies solely in delivering high quality, affordable products.

Our international team is constantly pursuing every effort to make products not just 'appliances' but 'lifestyle improvements'.

Check out all the latest Binatone products at:

[www.binatonelifestyle.com](http://www.binatonelifestyle.com)



# IMPORTANT SAFEGUARDS

When using electrical appliances – especially when children are present, basic safety precautions should always be followed to reduce the risk of fire, electric shock and/or injury to persons.

- ✓ READ ALL INSTRUCTIONS
- ✓ Make sure your power supply is consistent with the rated specification of the product before connecting.
- ✓ This appliance is not intended for use by persons (including children) with reduced physical, sensory or mental capabilities or lack of experience and knowledge – unless they are under supervision or instruction concerning use of the appliance by a person responsible for their safety. Children should be supervised to ensure that they do not play with the appliance.
- ✓ Do not operate any electrical appliance with a damaged cord or plug – or after the appliance malfunctions or has been dropped or damaged in any manner. Do not modify or repair the appliance yourself. Return the appliance to the nearest authorised service facility for examination, repair or adjustment.
- ✓ This appliance is intended to be used in household only and similar applications such as:
  - staff kitchen areas in shops, offices and other working environments
  - farm houses
  - by clients in hotels, motels and other residential type environments
  - bed and breakfast type environments.
- ✓ To protect against electric shock, do not place the product, cord or plug in water or other liquid.
- ✓ Do not pull, twist or otherwise abuse the power cord.
- ✓ Use this appliance only for its intended use – as described in this manual.
- ✓ The use of accessories attachments not included, recommended, or sold by Binatone is prohibited and may cause damage, fire, electric shock or injury.
- ✓ To avoid a circuit overload, do not operate any other high voltage equipment on the same circuit.
- ✓ Always disconnect the appliance from the supply if it left unattended and before assembling, disassembling, moving, cleaning and storing it.
- ✓ Do not let the power cord hang over the edge of your table or counter and do not allow the power cord or the appliance to come into contact with hot surfaces.
- ✓ Position the appliance and the cord so that nobody can accidentally overturn it.
- ✓ Do not place the appliance on or near a hot gas or electric burner, or in a heated oven.
- ✓ Do not cover the appliance when it is hot or in use.
- ✓ Do not use the appliance if it has mechanical defects (dents, cracks etc). Get it checked by the nearest authorized service centre.

## SPECIAL SAFETY MEASURES

- ▶ Misuse of your air fryer can result in injury.
- ▶ Never leave the appliance unattended while plugged in or while switched on.
- ▶ Care should be taken when handling the hot Inner & Outer Baskets.
- ▶ Do not leave foreign objects, such as spoons, forks, knives, etc., in the air fryer, this may cause damage.
- ▶ Do not overfill the basket. This could cause damage to the product
- ▶ After cooking - allow the appliance to cool for at least 30 minutes, before handling or cleaning.

## SPECIFICATION

Voltage: 220-240V~ 50-60Hz 1600W

Capacity: 6.5L Bowl

## KNOW YOUR APPLIANCE

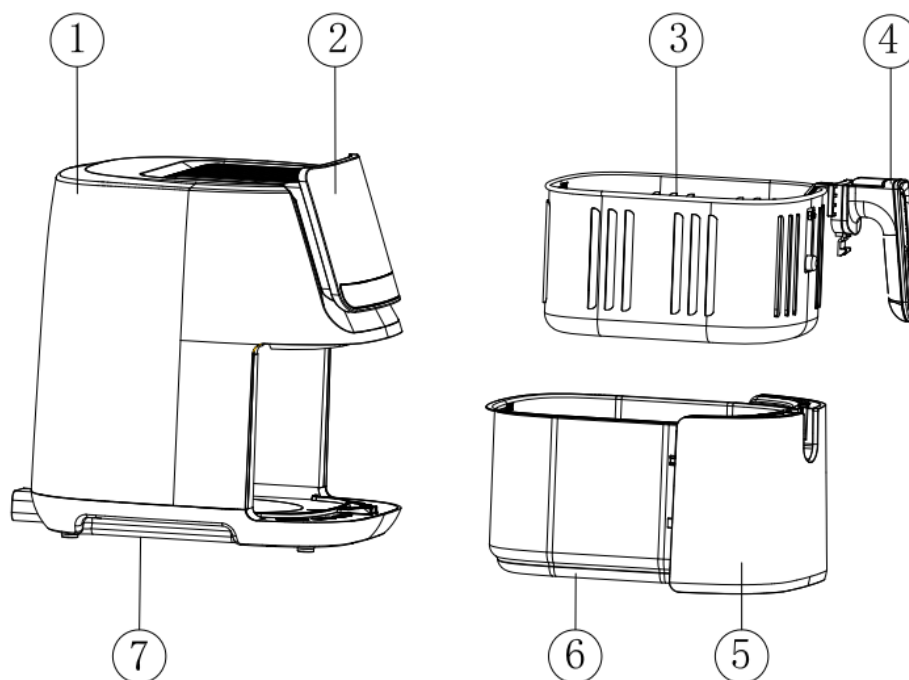

1. Main Body
2. Touch Control panel
3. Inner Basket

4. Release Button
5. Outer basket front face
6. Outer Basket

## BEFORE FIRST USE

Carefully remove all packaging from the appliance and its accessories. Clean and dry the appliance thoroughly as described in the "CARE AND CLEANING" section.

# SETUP INSTRUCTIONS

During first use, you may experience some slight odour & smoke – this is normal and will cease after a few minutes as remnants of production cleaning materials evaporate.

- Place the appliance on a dry, flat and stable working surface.
- Do not operate the appliance near the edge of the work surface.
- This appliance works on hot air. Do not fill any oil or other liquids into the basket assembly (3&6).
- The appliance will not work if the basket assembly (3&6) is not inserted properly.
- Always unplug the appliance after each use.

# OPERATING INSTRUCTIONS

1. Insert the power plug into the main supply outlet.
2. Pull out the basket assembly (3&6). Check and ensure that the inner basket (3) is placed properly and securely in the outer basket (6).
3. Place the ingredients into the inner basket (3). Do not fill above the MAX level as indicated on the frying basket.

4. Slide the basket assembly (3&6) back into the appliance.

**Note:** Never use the outer basket (6) without the inner basket (3) in it.

5. Press the power button "  ".

Then select the desired preset program, adjust temperature, adjust time, and then press the power button again.

The control panel shows the set temperature and the set cooking duration, and then the time begins to count down.





**Note:** There are 10 preset program functions available: chips, bread, drumsticks, chicken, sausage, pizza, fish, shrimp, steak & bacon.

Food symbols on the control panel allow you to select the presets programs directly.

Additionally, you can adjust the cooking time & temperature of the preset – allowing total flexibility.

Press the button "  "

When the time is displayed, press this button "   " to adjusted the time

When the temperature is displayed, then press this button "   " to adjust the temperature (each press of "   " will adjust temperature 5°C)

# 10 preset program functions table

Preset	Icon	Default Temp(°F)	Default Time (Min)
Chips		200	15
Bread		160	40
Drumsticks		200	20
Chicken		200	30
Sausage		180	15
Pizza,		180	30
Fish		160	20
Shrimp		180	20
Steak		180	20
Bacon		150	15

**Note:** During operation, the heating indicator light goes on and off periodically. This indicates that the heating element is switched on and off to maintain the set temperature. This is a normal feature of the Binatone Air Fryer, and not a malfunction.







- Oil collected from ingredients will collect at the bottom of the outer basket.
- Some ingredients require shaking halfway during the cooking time. To shake the ingredients, pull the basket assembly (3&6) out of the appliance by the handle and shake it. Then slide it back into the appliance. You can remove the inner basket (3) from the outer basket (6) to reduce the weight when shaking. To do so, put the basket assembly (3&6) on a heat-resistant surface, pull the clear button cover on handle towards you and press the release button to release the inner basket (6).

**Note:** When the basket is removed, the air fryer will automatically turn off.

- When the basket is pushed back into the appliance, the operation will continue for the remaining time and at the selected temperature.
6. If you press the on/off icon power after removing the basket, the device will not continue to work after returning the basket and must be restarted: reset the settings to the default settings.
  7. After completing a cooking program/cycle, the heater will automatically stop and the fan will continue for 20 seconds, as a safety feature. Finally, when cooking is completed the appliance will emit five beeps. Remove the basket from the appliance and place it on a heat resistance mat.
  8. Check if the food is cooked well. If the food is not ready, simply slide the basket back into the appliance and set the timer to a few minutes for extra cooking.
  9. To remove small ingredients, pull the slide cover on handle and press the basket release button to lift the inner basket out and pour out the ingredients to a bowl or a plate. To remove large ingredients, use a pair of tongs.
- Note:** Do not turn the basket upside down with the outer basket still attached. Even though you may not have used any oil for the cooking process and ingredients you have chosen, it is possible that the ingredients release their own fats and oils during the process. Excess oil from the ingredients gets collected at the bottom of the outer basket, turning or holding the basket upside down may cause the oil to leak onto the ingredients.
10. After the cooking is done, the appliance is instantly ready to prepare another batch of ingredients if needed.
  11. Once you have finished using the appliance, press the power button "".  
Then unplug and allow the appliance to cool down for at least 30 minutes, before handling, storing or cleaning.

## Frying Table

The table below indicates approximate guidelines on cooking. Please keep in mind that the cooking times and temperatures are for reference only. It must be adjusted according to the quantity and size of food and personal tastes. If the instructions on the product pack differ from the values shown in this table, the instructions on the pack should be followed instead.

Food		Time (min.)	Temperature (°C)	Shake or Turn/halfway	Notes
	Fries	12-18	200	Shake	Just add a touch of oil to suit your taste by brushing it on these ingredients
	Drumstick	15-20	180	Shake	-
	Meat	6-8	180	Turn	-
	Shrimp	10-15	180	Turn	-
	Cake	25-30	140	-	-
	Fish	10-15	200	Turn	-
	Ribs	15-25	180	Turn	-

Snacks				
Spring rolls	8-10	200	Shake	Use oven-ready
Frozen chicken nuggets	6-10	200	Shake	Use oven-ready
Frozen fish fingers	6-10	200	-	Use oven-ready
Frozen bread crumbed cheese snacks	10	200	-	Use oven-ready
Stuffed vegetables	10	160	-	Use oven-ready



## Cooking Tips

- Do not air fry fresh potatoes at a temperature over 180°C (to minimize the production of acrylamide).
- Preheat the appliance without any ingredients inside, set the temperature to 200°C and set the time for at least 3 minutes. Then fill the basket, set the temperature and cooking time to start cooking.
- To get even results we suggest shaking or turning smaller ingredients halfway through the cooking process, and then reinserting the basket to continue the cooking process.
- Smaller ingredients usually require a slightly shorter cooking time than larger ingredients.
- A large amount of ingredients requires a little longer cooking time.
- Health enthusiasts may avoid oil totally however we understand that several chefs suggest a touch of oil to maximize the taste and flavour. For those who prefer to add some oil, we suggest applying oil evenly to the contents, preferably by using a brush instead of just pouring it.
- For crispy and tasty fries using fresh potatoes, a touch of oil, preferably applied with a brush, is recommended. Fry your ingredients in the Binatone air fryer within a few minutes after applying the oil.
- Do not cook extremely greasy food items such as sausages in the air fryer.
- All snacks that can be prepared in an oven can also be prepared in the air fryer.
- This Binatone Air Fryer can also be used for reheating your food. For this, set the temperature to 150°C for up to 10 minutes.
- We recommend cooking your food to golden-yellow level and avoiding burning it to dark brown colour.

## CARE AND CLEANING

- Always disconnect from the power outlet and let it cool down to room temperature before cleaning, assembling and storage.
- Always clean the appliance and its accessories immediately after use so food won't dry on them.
- Wipe the base and power cord with a damp cloth after each use.

**Note:** Never immerse the main body (1) and the power cord in water or any other liquids or place them under running water.

- Do not use abrasive materials, - steel wool, abrasive cleaners or corrosive liquids (such as alcohol, gasoline, acetone etc.), to clean the appliance.
- Empty the bowl before washing. Wash the bowl & bowl lid in soapy water. Rinse them then dry. Do not use any sharp or abrasive detergents.  
If food sticks to the wall of the bowl, use the spatula to remove the food from the wall.

**Note:** Never use metal utensils, as damage may occur to the bowl material.

## SERVICE & CUSTOMER CARE





There are no user serviceable parts inside this appliance.

If the power cord or plug are damaged it must, for safety reasons, be replaced by Binatone or an authorised Binatone repairer.

If you need help with:

- using your product
- servicing or repairs (in or out of guarantee)
- spare parts

Please contact Binatone Customer Service at:

	<p><a href="http://www.binatonelifestyle.com/binatone/customer-service/">www.binatonelifestyle.com/binatone/customer-service/</a></p>	
	<p><a href="https://www.facebook.com/BinatoneAfrica">www.facebook.com/BinatoneAfrica</a> or search @BinatoneAfrica in Facebook or Messenger to find this page easily.</p>	

Have your model number & batch code ready – it is located on the rating label on your product

# WARRANTY

**Save your proof of purchase sales receipt.**



BINATONE warrants, subject to the conditions stated below, that from the date of purchase, this product will be free from mechanical defects for a period of two (2) years.

This is a domestic product – warranty does not cover products that have been used for commercial purposes.

BINATONE at its option, will repair or replace a product found to be defective during the warranty period. Should this product become defective by reason of improper workmanship or material defect during the specified warranty period, BINATONE will repair or replace the same effecting all necessary part replacements.

Transportation charges on parts, or products in whole, submitted for repair or replacement, under this warranty, must be borne by the purchaser.

CONDITIONS: This warranty is valid for the original retail purchaser from the date of initial retail purchase and is not transferable. Keep the original sales receipt. Proof of purchase is required to obtain warranty service or replacement. Dealers, service centres, or retail stores do not have the right to alter, modify or in any way, change the terms and conditions of this warranty.

Warranty registration is not necessary to obtain warranty on BINATONE products.

ABOUT YOUR PRODUCT WARRANTY: Most warranty repairs are handled routinely, but sometimes requests for warranty service may not be appropriate. For example, warranty service would NOT apply if the product damage occurred because of misuse, lack of routine maintenance, shipping, handling, warehousing or improper installation. Similarly, the warranty is void if the manufacturing date or the serial number on the product has been removed or the equipment has been altered or modified. During the warranty period, the authorized service dealer, at its option, will repair or replace any part that, upon examination, is found to be defective under normal use and service.

NORMAL WEAR & SERVICE/REPLACEABLE PARTS: This warranty does not cover normal wear of parts or damage resulting from any of the following: Negligent use or misuse of the product; Improper voltage or current; Use contrary to the operation instructions; Deviation from instructions regarding storage and transportation; Repair or alteration by anyone other than BINATONE or an authorized service centre; service parts replaced by user. Further, the warranty does not cover Acts of God, such as fire, flood, hurricanes, tornadoes etc.

Customers connecting BINATONE appliances directly to the mains power outlet or using a non-BINATONE stabilizer, risk voiding their BINATONE warranty. We recommend using quality BINATONE stabilizers for your protection – be wise, buy the best – always buy BINATONE

HOW TO OBTAIN WARRANTY SERVICE: Please contact BINATONE Customer Service (see Service & Customer Care section)



**Please consider recycling this  
instruction manual responsibly**

**Binatone Lifestyle Appliances**

**• LONDON • HONG KONG • DUBAI • LAGOS • ACCRA •**